

MC33033, NCV33033

Brushless DC Motor Controller

The MC33033 is a high performance second generation, limited feature, monolithic brushless dc motor controller which has evolved from ON Semiconductor's full featured MC33034 and MC33035 controllers. It contains all of the active functions required for the implementation of open loop, three or four phase motor control. The device consists of a rotor position decoder for proper commutation sequencing, temperature compensated reference capable of supplying sensor power, frequency programmable sawtooth oscillator, fully accessible error amplifier, pulse width modulator comparator, three open collector top drivers, and three high current totem pole bottom drivers ideally suited for driving power MOSFETs. Unlike its predecessors, it does not feature separate drive circuit supply and ground pins, brake input, or fault output signal.

Included in the MC33033 are protective features consisting of undervoltage lockout, cycle-by-cycle current limiting with a selectable time delayed latched shutdown mode, and internal thermal shutdown.

Typical motor control functions include open loop speed, forward or reverse direction, and run enable. The MC33033 is designed to operate brushless motors with electrical sensor phasings of 60°/300° or 120°/240°, and can also efficiently control brush dc motors.

Features

- 10 to 30 V Operation
- Undervoltage Lockout
- 6.25 V Reference Capable of Supplying Sensor Power
- Fully Accessible Error Amplifier for Closed Loop Servo Applications
- High Current Drivers Can Control External 3-Phase MOSFET Bridge
- Cycle-By-Cycle Current Limiting
- Internal Thermal Shutdown
- Selectable 60°/300° or 120°/240° Sensor Phasings
- Also Efficiently Control Brush DC Motors with External MOSFET H-Bridge
- NCV Prefix for Automotive and Other Applications Requiring Unique Site and Control Change Requirements; AEC-Q100 Qualified and PPAP Capable
- Pb-Free Packages are Available



ON Semiconductor®

<http://onsemi.com>

PDIP-20
P SUFFIX
CASE 738

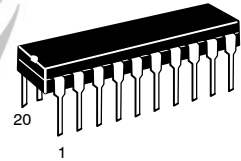

SO-20L
DW SUFFIX
CASE 751D

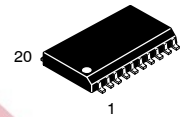

PIN CONNECTIONS

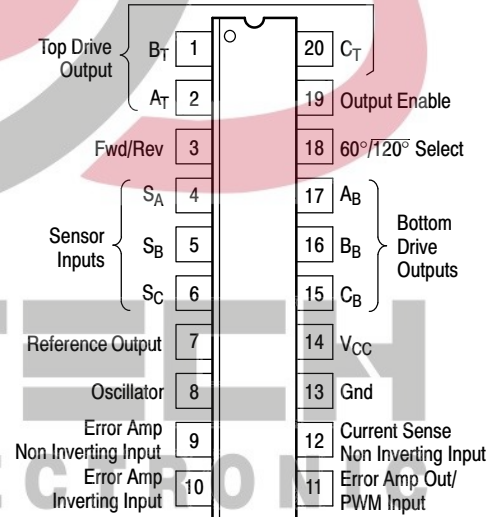

(Top View)

ORDERING INFORMATION

See detailed ordering and shipping information in the package dimensions section on page 25 of this data sheet.

DEVICE MARKING INFORMATION

See general marking information in the device marking section on page 25 of this data sheet.

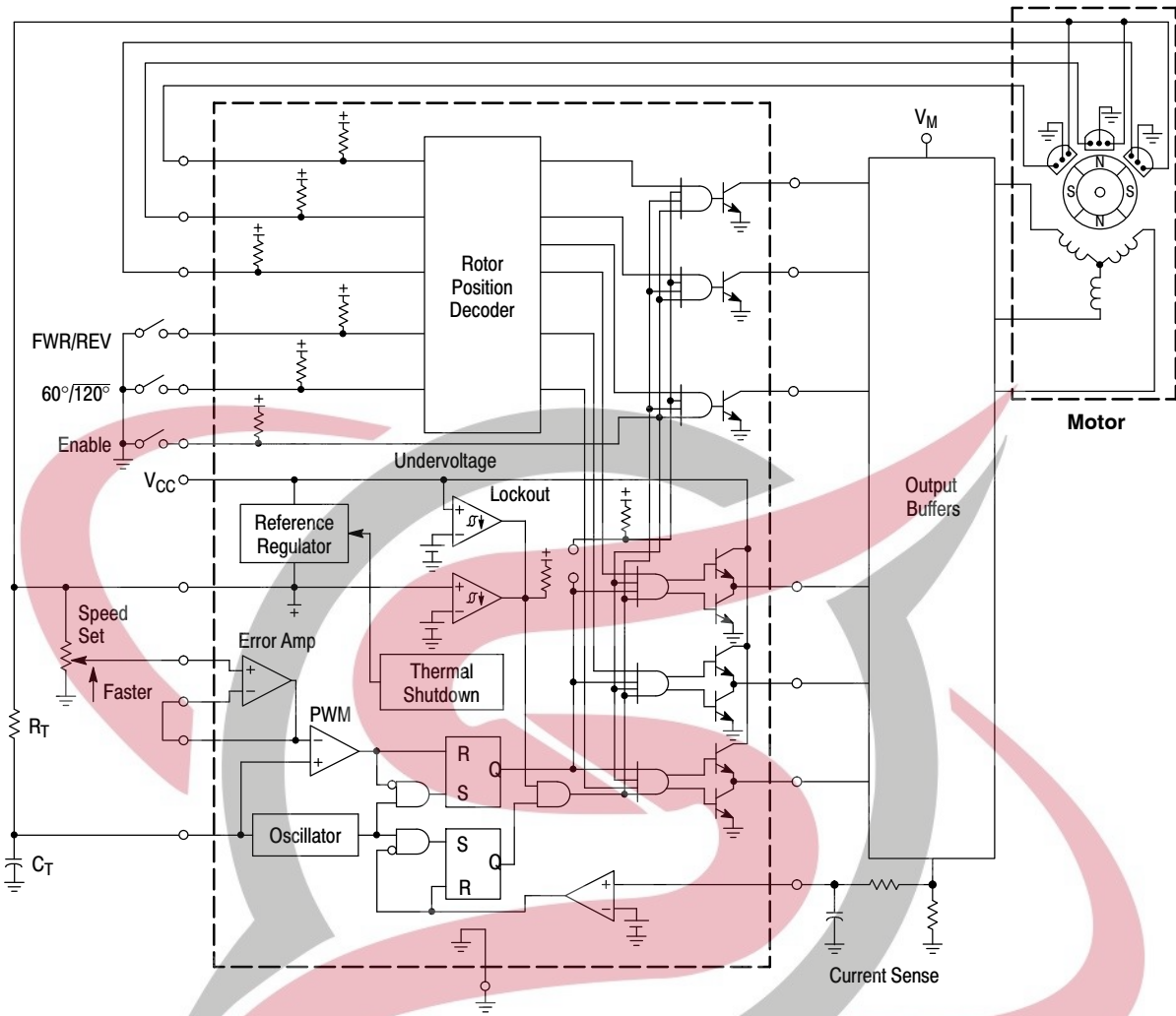

This device contains 266 active transistors.

Figure 1. Representative Schematic Diagram



MAXIMUM RATINGS

Rating	Symbol	Value	Unit
Power Supply Voltage	V_{CC}	30	V
Digital Inputs (Pins 3, 4, 5, 6, 18, 19)	-	V_{ref}	V
Oscillator Input Current (Source or Sink)	I_{OSC}	30	mA
Error Amp Input Voltage Range (Pins 9, 10, Note 1)	V_{IR}	-0.3 to V_{ref}	V
Error Amp Output Current (Source or Sink, Note 2)	I_{Out}	10	mA
Current Sense Input Voltage Range	V_{Sense}	-0.3 to 5.0	V
Top Drive Voltage (Pins 1, 2, 20)	$V_{CE(top)}$	40	V
Top Drive Sink Current (Pins 1, 2, 20)	$I_{Sink(top)}$	50	mA
Bottom Drive Output Current (Source or Sink, Pins 15,16, 17)	I_{DRV}	100	mA
Electrostatic Discharge Sensitivity (ESD)			
Human Body Model (HBM) Class 2, JESD22 A114-C	-	2000	V
Machine Model (MM) Class A, JESD22 A115-A	-	200	V
Charged Device Model (CDM), JESD22 C101-C	-	2000	V
Power Dissipation and Thermal Characteristics			
P Suffix, Dual-In-Line, Case 738			
Maximum Power Dissipation @ $T_A = 85^{\circ}C$	P_D	867	mW
Thermal Resistance, Junction-to-Air	$R_{\theta JA}$	75	$^{\circ}C/W$
DW Suffix, Surface Mount, Case 751D			
Maximum Power Dissipation @ $T_A = 85^{\circ}C$	P_D	619	mW
Thermal Resistance, Junction-to-Air	$R_{\theta JA}$	105	$^{\circ}C/W$
Operating Junction Temperature	T_J	150	$^{\circ}C$
Operating Ambient Temperature Range (Note 3)	T_A	-40 to +85 -40 to +125	$^{\circ}C$
		MC33033 NCV33033	
Storage Temperature Range	T_{stg}	-65 to +150	$^{\circ}C$

Stresses exceeding Maximum Ratings may damage the device. Maximum Ratings are stress ratings only. Functional operation above the Recommended Operating Conditions is not implied. Extended exposure to stresses above the Recommended Operating Conditions may affect device reliability.

1. The input common mode voltage or input signal voltage should not be allowed to go negative by more than 0.3 V.
2. The compliance voltage must not exceed the range of -0.3 to V_{ref} .
3. NCV33033: $T_{low} = -40^{\circ}C$, $T_{high} = 125^{\circ}C$. Guaranteed by design. NCV prefix is for automotive and other applications requiring site and change control.



MC33033, NCV33033

ELECTRICAL CHARACTERISTICS ($V_{CC} = 20\text{ V}$, $R_T = 4.7\text{ k}$, $C_T = 10\text{ nF}$, $T_A = 25^\circ\text{C}$, unless otherwise noted.)

Characteristic	Symbol	Min	Typ	Max	Unit
----------------	--------	-----	-----	-----	------

REFERENCE SECTION

Reference Output Voltage ($I_{ref} = 1.0\text{ mA}$) $T_A = 25^\circ\text{C}$ (Note 4)	V_{ref}	5.9 5.82	6.24 –	6.5 6.57	V
Line Regulation ($V_{CC} = 10\text{ V to }30\text{ V}$, $I_{ref} = 1.0\text{ mA}$)	Reg_{line}	–	1.5	30	mV
Load Regulation ($I_{ref} = 1.0\text{ mA to }20\text{ mA}$)	Reg_{load}	–	16	30	mV
Output Short-Circuit Current (Note 5)	I_{SC}	40	75	–	mA
Reference Under Voltage Lockout Threshold	V_{th}	4.0	4.5	5.0	V

ERROR AMPLIFIER

Input Offset Voltage (Note 4)	V_{IO}	–	0.4	10	mV
Input Offset Current (Note 4)	I_{IO}	–	8.0	500	nA
Input Bias Current (Note 4)	I_{IB}	–	–46	–1000	nA
Input Common Mode Voltage Range	V_{ICR}	(0 V to V_{ref})			V
Open Loop Voltage Gain ($V_O = 3.0\text{ V}$, $R_L = 15\text{ k}$)	A_{VOL}	70	80	–	dB
Input Common Mode Rejection Ratio	CMRR	55	86	–	dB
Power Supply Rejection Ratio ($V_{CC} = 10\text{ V to }30\text{ V}$)	PSRR	65	105	–	dB
Output Voltage Swing High State ($R_L = 15\text{ k to Gnd}$) Low State ($R_L = 17\text{ k to }V_{ref}$)	V_{OH} V_{OL}	4.6 –	5.3 0.5	– 1.0	V

4. MC33033: $T_A = -40^\circ\text{C to }+85^\circ\text{C}$; NCV33033: $T_A = -40^\circ\text{C to }+125^\circ\text{C}$.
5. Maximum package power dissipation limits must be observed.

SKYTECH
ELECTRONIC

MC33033, NCV33033

ELECTRICAL CHARACTERISTICS (continued) ($V_{CC} = 20\text{ V}$, $R_T = 4.7\text{ k}$, $C_T = 10\text{ nF}$, $T_A = 25^\circ\text{C}$, unless otherwise noted.)

Characteristic	Symbol	Min	Typ	Max	Unit
OSCILLATOR SECTION					
Oscillator Frequency	f_{OSC}	22	25	28	kHz
Frequency Change with Voltage ($V_{CC} = 10\text{ V}$ to 30 V)	$\Delta f_{OSC}/\Delta V$	-	0.01	5.0	%
Sawtooth Peak Voltage	$V_{OSC(P)}$	-	4.1	4.5	V
Sawtooth Valley Voltage	$V_{OSC(V)}$	1.2	1.5	-	V
LOGIC INPUTS					
Input Threshold Voltage (Pins 3, 4, 5, 6, 18, 19) High State Low State	V_{IH} V_{IL}	3.0 -	2.2 1.7	- 0.8	V
Sensor Inputs (Pins 4, 5, 6) High State Input Current ($V_{IH} = 5.0\text{ V}$) Low State Input Current ($V_{IL} = 0\text{ V}$)	I_{IH} I_{IL}	-150 -600	-70 -337	-20 -150	μA
Forward/Reverse, $60^\circ/120^\circ$ Select and Output Enable (Pins 3, 18, 19) High State Input Current ($V_{IH} = 5.0\text{ V}$) Low State Input Current ($V_{IL} = 0\text{ V}$)	I_{IH} I_{IL}	-75 -300	-36 -175	-10 -75	μA
CURRENT-LIMIT COMPARATOR					
Threshold Voltage	V_{th}	85	101	115	mV
Input Common Mode Voltage Range	V_{ICR}	-	3.0	-	V
Input Bias Current	I_{IB}	-	-0.9	-5.0	μA
OUTPUTS AND POWER SECTIONS					
Top Drive Output Sink Saturation ($I_{Sink} = 25\text{ mA}$)	$V_{CE(sat)}$	-	0.5	1.5	V
Top Drive Output Off-State Leakage ($V_{CE} = 30\text{ V}$)	$I_{DRV(leak)}$	-	0.06	100	μA
Top Drive Output Switching Time ($C_L = 47\text{ pF}$, $R_L = 1.0\text{ k}$) Rise Time Fall Time	t_r t_f	- -	107 26	300 300	ns
Bottom Drive Output Voltage High State ($V_{CC} = 30\text{ V}$, $I_{source} = 50\text{ mA}$) Low State ($V_{CC} = 30\text{ V}$, $I_{sink} = 50\text{ mA}$)	V_{OH} V_{OL}	$(V_{CC} - 2.0)$ -	$(V_{CC} - 1.1)$ 1.5	- 2.0	V
Bottom Drive Output Switching Time ($C_L = 1000\text{ pF}$) Rise Time Fall Time	t_r t_f	- -	38 30	200 200	ns
Under Voltage Lockout Drive Output Enabled (V_{CC} Increasing) Hysteresis	$V_{th(on)}$ V_H	8.2 0.1	8.9 0.2	10 0.3	V
Power Supply Current	I_{CC}	-	15	22	mA

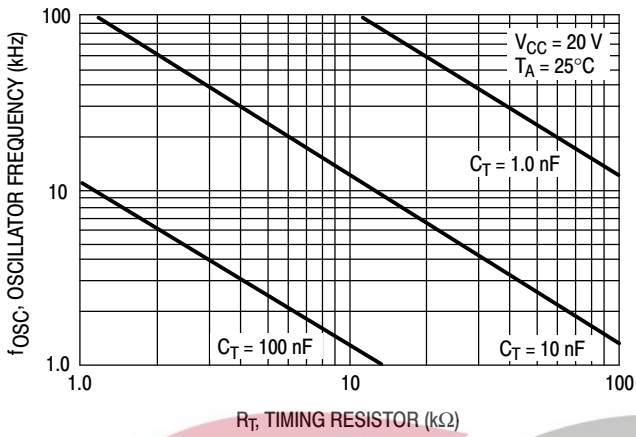

Figure 2. Oscillator Frequency versus Timing Resistor

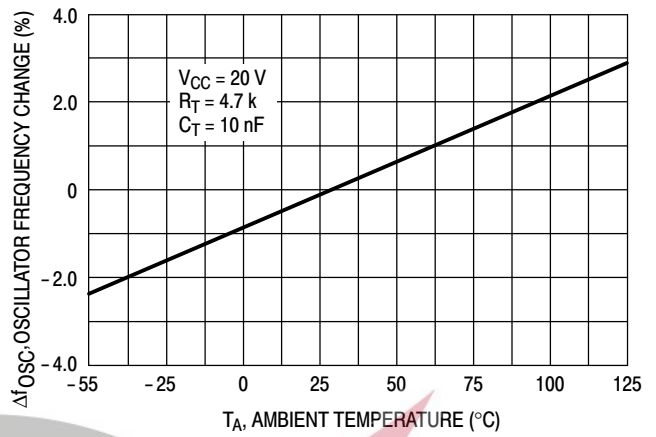

Figure 3. Oscillator Frequency Change versus Temperature

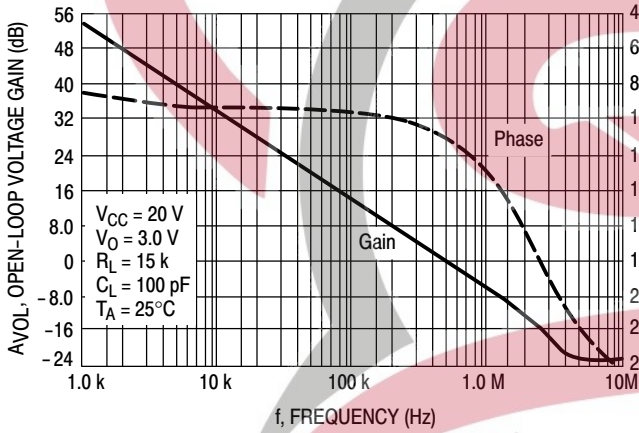

Figure 4. Error Amp Open Loop Gain and Phase versus Frequency

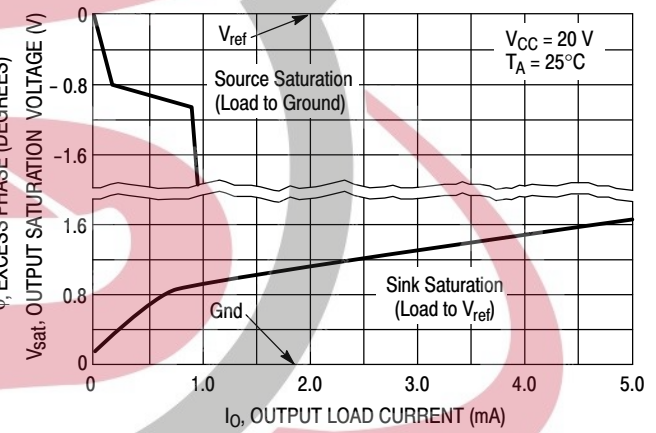

Figure 5. Error Amp Output Saturation Voltage versus Load Current

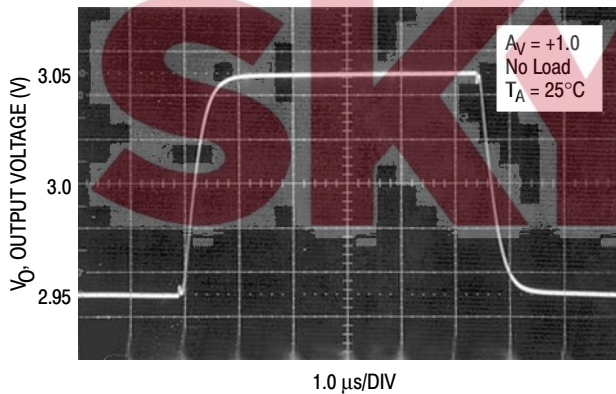

Figure 6. Error Amp Small-Signal Transient Response

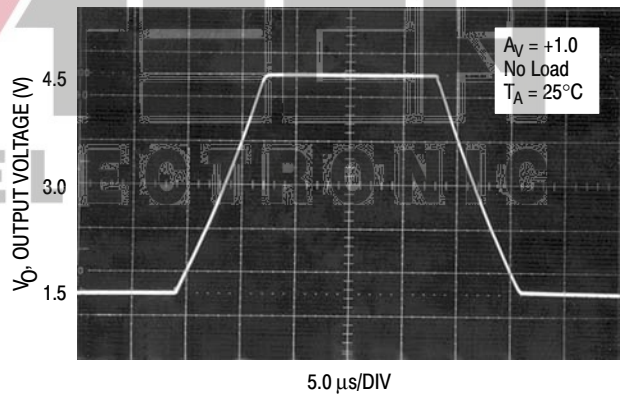

Figure 7. Error Amp Large-Signal Transient Response

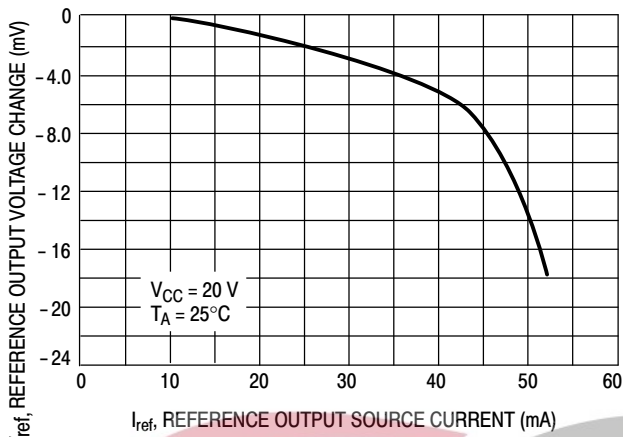

Figure 8. Reference Output Voltage Change versus Output Source Current

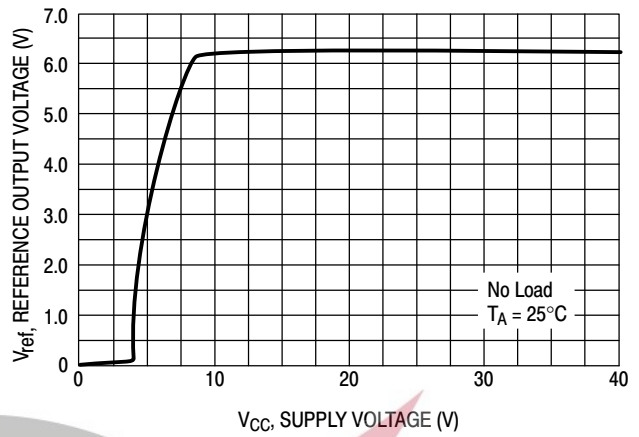

Figure 9. Reference Output Voltage versus Supply Voltage

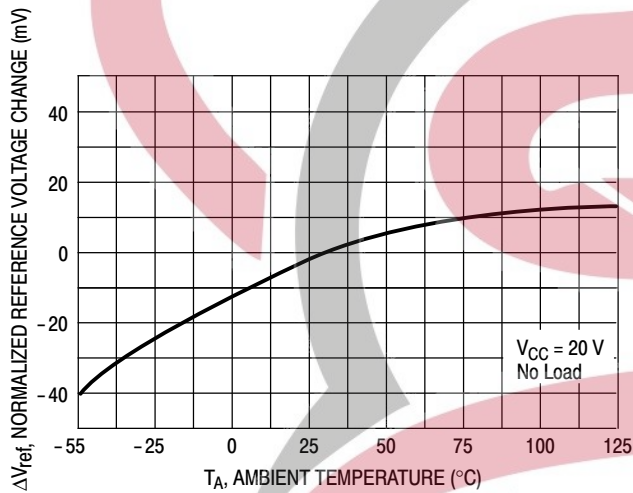

Figure 10. Reference Output Voltage versus Temperature

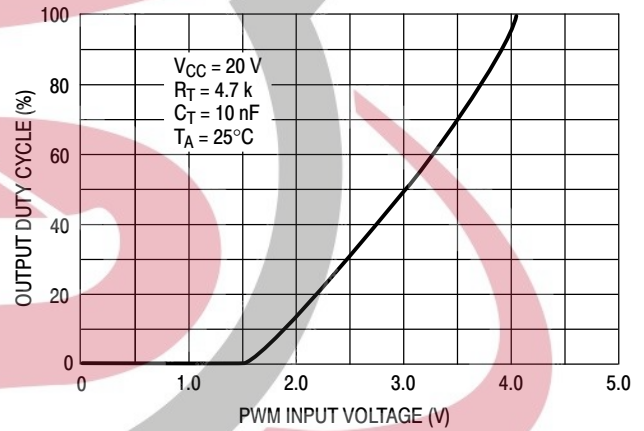

Figure 11. Output Duty Cycle versus PWM Input Voltage

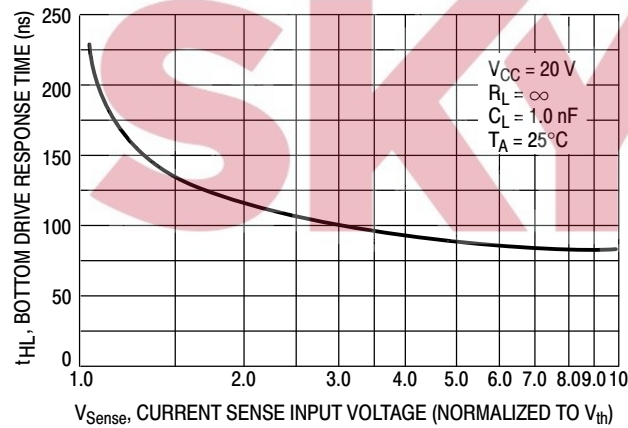

Figure 12. Bottom Drive Response Time versus Current Sense Input Voltage

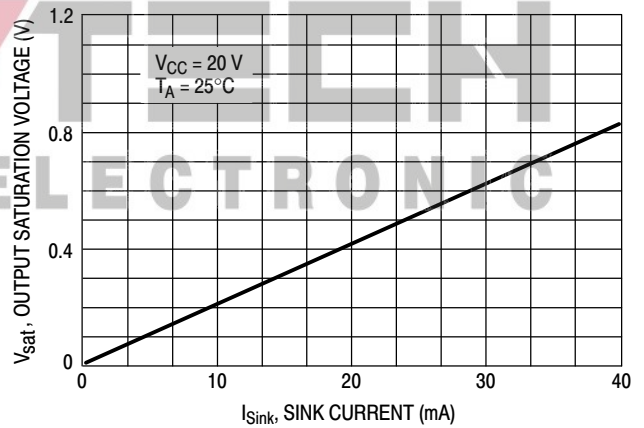

Figure 13. Top Drive Output Saturation Voltage versus Sink Current

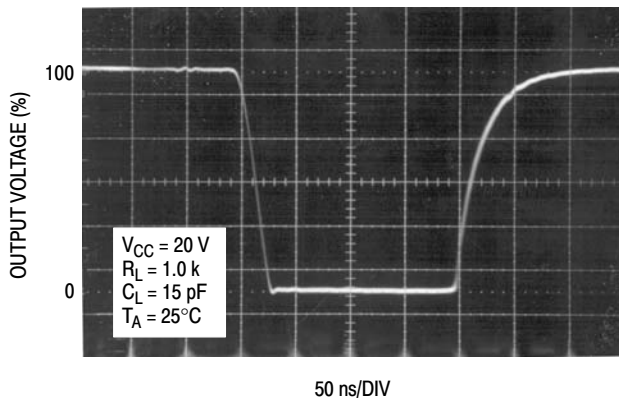

Figure 14. Top Drive Output Waveform

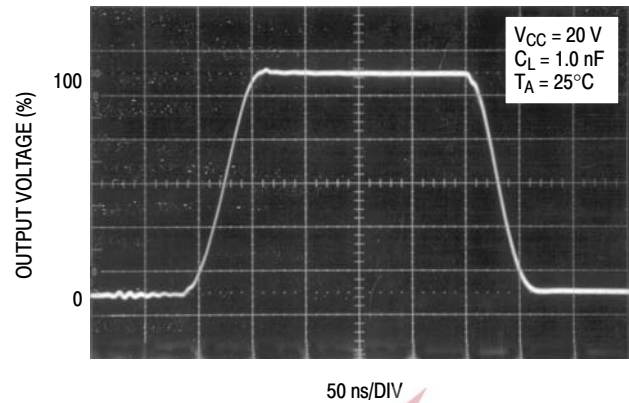

Figure 15. Bottom Drive Output Waveform

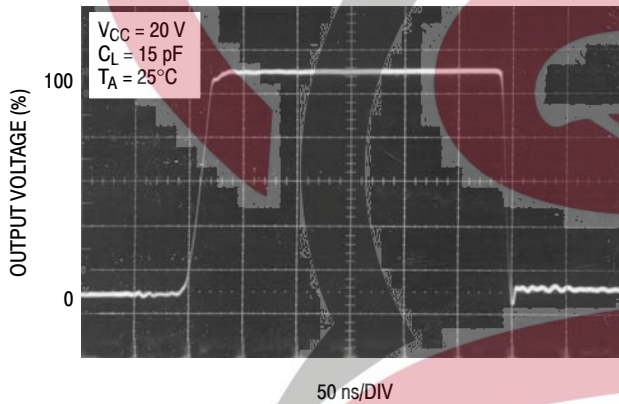

Figure 16. Bottom Drive Output Waveform

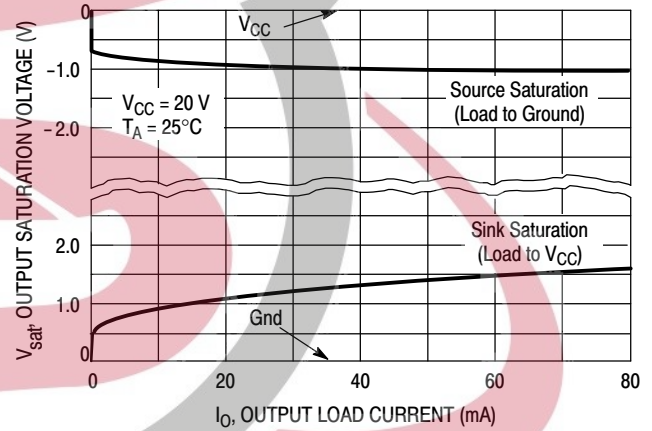

Figure 17. Bottom Drive Output Saturation Voltage versus Load Current

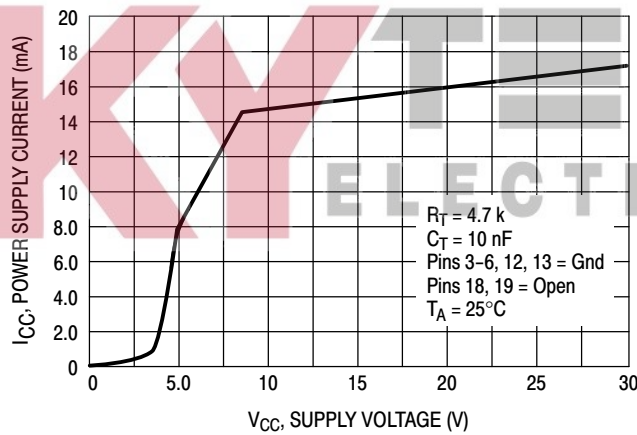

Figure 18. Supply Current versus Voltage

PIN FUNCTION DESCRIPTION

Pin	Symbol	Description
1, 2, 20	B_T, A_T, C_T	These three open collector Top Drive Outputs are designed to drive the external upper power switch transistors.
3	Fwd//Rev	The Forward/Reverse Input is used to change the direction of motor rotation.
4, 5, 6	S_A, S_B, S_C	These three Sensor Inputs control the commutation sequence.
7	Reference Output	This output provides charging current for the oscillator timing capacitor C_T and a reference for the Error Amplifier. It may also serve to furnish sensor power.
8	Oscillator	The Oscillator frequency is programmed by the values selected for the timing components, R_T and C_T .
9	Error Amp Noninverting Input	This input is normally connected to the speed set potentiometer.
10	Error Amp Inverting Input	This input is normally connected to the Error Amp Output in open loop applications.
11	Error Amp Out/PWM Input	This pin is available for compensation in closed loop applications.
12	Current Sense Noninverting Input	A 100 mV signal, with respect to Pin 13, at this input terminates output switch conduction during a given oscillator cycle. This pin normally connects to the top side of the current sense resistor.
13	Gnd	This pin supplies a separate ground return for the control circuit and should be referenced back to the power source ground.
14	V_{CC}	This pin is the positive supply of the control IC. The controller is functional over a V_{CC} range of 10 to 30 V.
15, 16, 17	C_B, B_B, A_B	These three totem pole Bottom Drive Outputs are designed for direct drive of the external bottom power switch transistors.
18	60°/120° Select	The electrical state of this pin configures the control circuit operation for either 60° (high state) or 120° (low state) sensor electrical phasing inputs.
19	Output Enable	A logic high at this input causes the motor to run, while a low causes it to coast.



SKYTECH
ELECTRONIC

INTRODUCTION

The MC33033 is one of a series of high performance monolithic dc brushless motor controllers produced by ON Semiconductor. It contains all of the functions required to implement a limited-feature, open loop, three or four phase motor control system. Constructed with Bipolar Analog technology, it offers a high degree of performance and ruggedness in hostile industrial environments. The MC33033 contains a rotor position decoder for proper commutation sequencing, a temperature compensated reference capable of supplying sensor power, a frequency programmable sawtooth oscillator, a fully accessible error amplifier, a pulse width modulator comparator, three open collector top drive outputs, and three high current totem pole bottom driver outputs ideally suited for driving power MOSFETs.

Included in the MC33033 are protective features consisting of undervoltage lockout, cycle-by-cycle current limiting with a latched shutdown mode, and internal thermal shutdown.

Typical motor control functions include open loop speed control, forward or reverse rotation, and run enable. In addition, the MC33033 has a $60^\circ/120^\circ$ select pin which configures the rotor position decoder for either 60° or 120° sensor electrical phasing inputs.

FUNCTIONAL DESCRIPTION

A representative internal block diagram is shown in Figure 19, with various applications shown in Figures 35, 37, 38, 42, 44, and 45. A discussion of the features and function of each of the internal blocks given below and referenced to Figures 19 and 37.

Rotor Position Decoder

An internal rotor position decoder monitors the three sensor inputs (Pins 4, 5, 6) to provide the proper sequencing of the top and bottom drive outputs. The Sensor Inputs are designed to interface directly with open collector type Hall Effect switches or opto slotted couplers. Internal pull-up resistors are included to minimize the required number of external components. The inputs are TTL compatible, with their thresholds typically at 2.2 V. The MC33033 series is designed to control three phase motors and operate with four of the most common conventions of sensor phasing. A $60^\circ/120^\circ$ Select (Pin 18) is conveniently provided which affords the MC33033 to configure itself to control motors having either 60° , 120° , 240° or 300° electrical sensor phasing. With three Sensor Inputs there are eight possible input code combinations, six of which are valid rotor positions. The remaining two codes are invalid and are usually caused by an open or shorted sensor line. With six valid input codes, the decoder can resolve the motor rotor position to within a window of 60 electrical degrees.

The Forward/Reverse input (Pin 3) is used to change the direction of motor rotation by reversing the voltage across the stator winding. When the input changes state, from high to low with a given sensor input code (for example 100), the enabled top and bottom drive outputs with the same alpha designation are exchanged (A_T to A_B , B_T to B_B , C_T to C_B). In effect the commutation sequence is reversed and the motor changes directional rotation.

Motor on/off control is accomplished by the Output Enable (Pin19). When left disconnected, an internal pull-up resistor to a positive source enables sequencing of the top and bottom drive outputs. When grounded, the Top Drive Outputs turn off and the bottom drives are forced low, causing the motor to coast.

The commutation logic truth table is shown in Figure 20. In half wave motor drive applications, the Top Drive Outputs are not required and are typically left disconnected.

Error Amplifier

A high performance, fully compensated Error Amplifier with access to both inputs and output (Pins 9, 10, 11) is provided to facilitate the implementation of closed loop motor speed control. The amplifier features a typical dc voltage gain of 80 dB, 0.6 MHz gain bandwidth, and a wide input common mode voltage range that extends from ground to V_{ref} . In most open loop speed control applications, the amplifier is configured as a unity gain voltage follower with the Noninverting Input connected to the speed set voltage source. Additional configurations are shown in Figures 30 through 34.

Oscillator

The frequency of the internal ramp oscillator is programmed by the values selected for timing components R_T and C_T . Capacitor C_T is charged from the Reference Output (Pin 7) through resistor R_T and discharged by an internal discharge transistor. The ramp peak and valley voltages are typically 4.1 V and 1.5 V respectively. To provide a good compromise between audible noise and output switching efficiency, an oscillator frequency in the range of 20 to 30 kHz is recommended. Refer to Figure 2 for component selection.

Pulse Width Modulator

The use of pulse width modulation provides an energy efficient method of controlling the motor speed by varying the average voltage applied to each stator winding during the commutation sequence. As C_T discharges, the oscillator sets both latches, allowing conduction of the Top and Bottom Drive Outputs. The PWM comparator resets the upper latch, terminating the Bottom Drive Output conduction when the positive-going ramp of C_T becomes greater than the Error Amplifier output. The pulse width modulator timing diagram is shown in Figure 21. Pulse width modulation for speed control appears only at the Bottom Drive Outputs.

MC33033, NCV33033

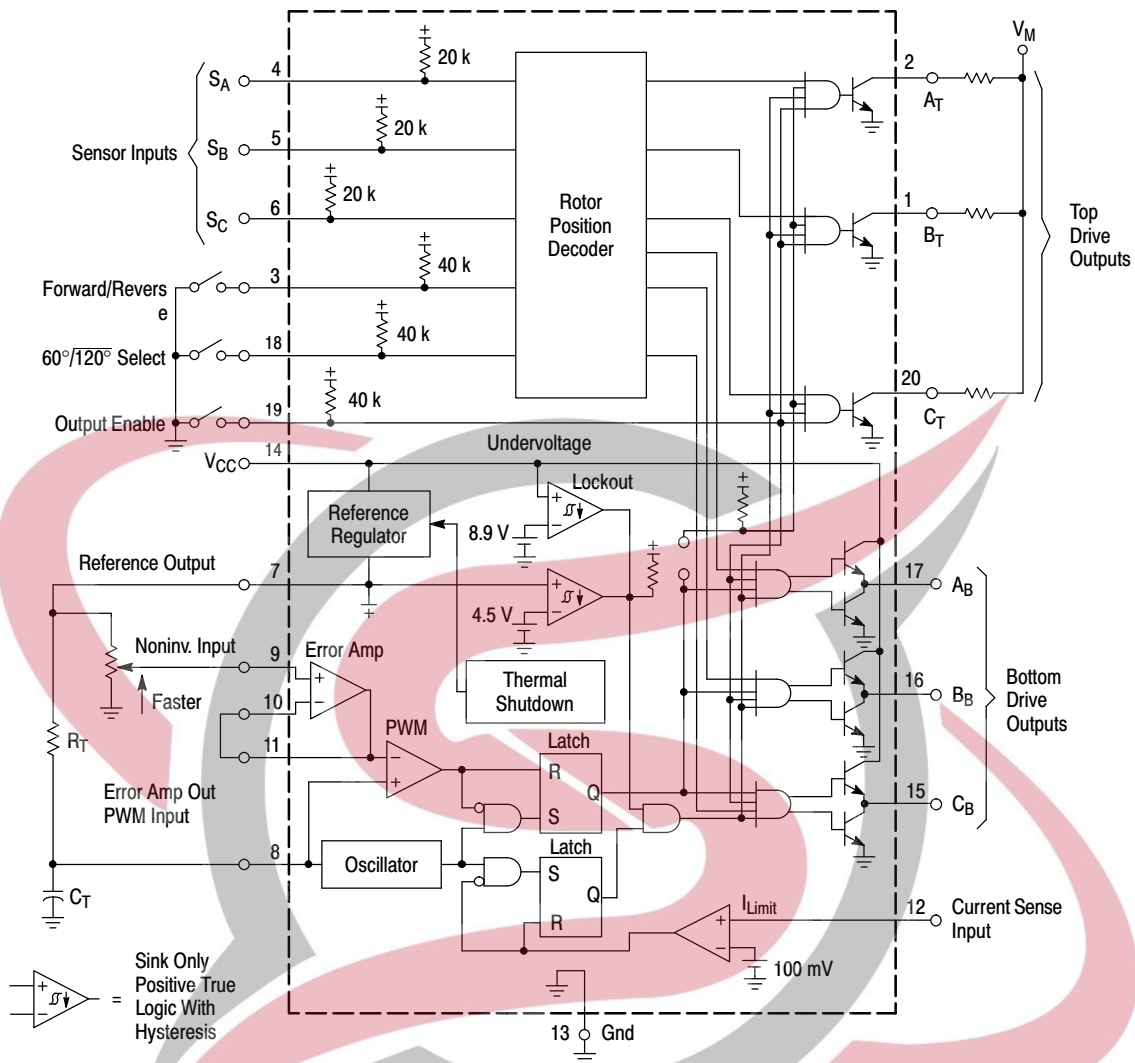

Figure 19. Representative Block Diagram

SKYTECH
ELECTRONIC

Inputs (Note 2)									Outputs (Note 3)							
Sensor Electrical Phasing (Note 4)						F/R	Enable	Current Sense	Top Drives			Bottom Drives				
60°			120°						A _T	B _T	C _T	A _B	B _B	C _B		
S _A	S _B	S _C	S _A	S _B	S _C											
1	0	0	1	0	0	1	1	0	0	1	1	0	0	0	1	(Note 5) F/R = 1
1	1	0	1	1	0	1	1	0	1	0	1	0	0	0	1	
1	1	1	0	1	0	1	1	0	1	0	1	1	0	0	0	
0	1	1	0	1	1	1	1	0	1	1	0	1	0	0	0	
0	0	1	0	0	1	1	1	0	1	1	0	0	1	0	0	
0	0	0	1	0	1	1	1	0	0	1	1	0	0	1	0	
1	0	0	1	0	0	0	1	0	1	1	0	1	0	0	0	(Note 5) F/R = 0
1	1	0	1	1	0	0	1	0	1	1	0	0	1	0	0	
1	1	1	0	1	0	0	1	0	0	1	1	0	1	0	0	
0	1	1	0	1	1	0	1	0	0	1	1	0	0	0	1	
0	0	1	0	0	1	0	1	0	1	0	1	0	0	0	1	
0	0	0	1	0	1	0	1	0	1	0	1	1	0	0	0	
1	0	1	1	1	1	X	X	X	1	1	1	0	0	0	0	(Note 6)
0	1	0	0	0	0	X	X	X	1	1	1	0	0	0	0	
V	V	V	V	V	V	X	0	X	1	1	1	0	0	0	0	(Note 7)
V	V	V	V	V	V	X	1	1	1	1	1	0	0	0	0	(Note 8)

- NOTES:** 1. V = Any one of six valid sensor or drive combinations.
X = Don't care.
2. The digital inputs (Pins 3, 4, 5, 6, 18, 19) are all TTL compatible. The current sense input (Pin 12) has a 100 mV threshold with respect to Pin 13. A logic 0 for this input is defined as < 85 mV, and a logic 1 is > 115 mV.
3. The top drive outputs are open collector design and active in the low (0) state.
4. With 60°/120° (Pin 18) in the high (1) state, configuration is for 60° sensor electrical phasing inputs. With Pin 18 in the low (0) state, configuration is for 120° sensor electrical phasing inputs.
5. Valid 60° or 120° sensor combinations for corresponding valid top and bottom drive outputs.
6. Invalid sensor inputs; All top and bottom drives are off.
7. Valid sensor inputs with enable = 0; All top and bottom drives are off.
8. Valid sensor inputs with enable and current sense = 1; All top and bottom drives are off.

Figure 20. Three Phase, Six Step Commutation Truth Table (Note 1)

Current Limit

Continuous operation of a motor that is severely over-loaded results in overheating and eventual failure. This destructive condition can best be prevented with the use of cycle-by-cycle current limiting. That is, each on-cycle is treated as a separate event. Cycle-by-cycle current limiting is accomplished by monitoring the stator current build-up each time an output switch conducts, and upon sensing an over current condition, immediately turning off the switch and holding it off for the remaining duration of oscillator ramp-up period. The stator current is converted to a voltage by inserting a ground-referenced sense resistor R_S (Figure 35) in series with the three bottom switch transistors (Q₄, Q₅, Q₆). The voltage developed across the sense resistor is monitored by the current sense input (Pin 12), and compared to the internal 100 mV reference. If the current sense threshold is exceeded, the comparator resets the lower latch and terminates output switch conduction. The value for the sense resistor is:

$$R_S = \frac{0.1}{I_{\text{stator(max)}}$$

The dual-latch PWM configuration ensures that only one single output conduction pulse occurs during any given oscillator cycle, whether terminated by the output of the Error Amplifier or the current limit comparator.

Reference

The on-chip 6.25 V regulator (Pin 7) provides charging current for the oscillator timing capacitor, a reference for the Error Amplifier, and can supply 20 mA of current suitable for directly powering sensors in low voltage applications. In higher voltage applications it may become necessary to transfer the power dissipated by the regulator off the IC. This is easily accomplished with the addition of an external pass transistor as shown in Figure 22. A 6.25 V reference level was chosen to allow implementation of the simpler NPN circuit, where V_{ref} - V_{BE} exceeds the minimum voltage required by Hall Effect sensors over temperature. With proper transistor selection, and adequate heatsinking, up to one amp of load current can be obtained.

Undervoltage Lockout

A dual Undervoltage Lockout has been incorporated to prevent damage to the IC and the external power switch transistors. Under low power supply conditions, it guarantees that the IC and sensors are fully functional, and that there is sufficient Bottom Drive Output voltage. The positive power supply to the IC (V_{CC}) is monitored to a threshold of 8.9 V. This level ensures sufficient gate drive necessary to attain low R_{DS(on)} when interfacing with standard power MOSFET devices. When directly powering the Hall sensors from the reference, improper sensor

operation can result if the reference output voltage should fall below 4.5 V. If one or both of the comparators detects an undervoltage condition, the top drives are turned off and the

Bottom Drive Outputs are held in a low state. Each of the comparators contain hysteresis to prevent oscillations when crossing their respective thresholds.

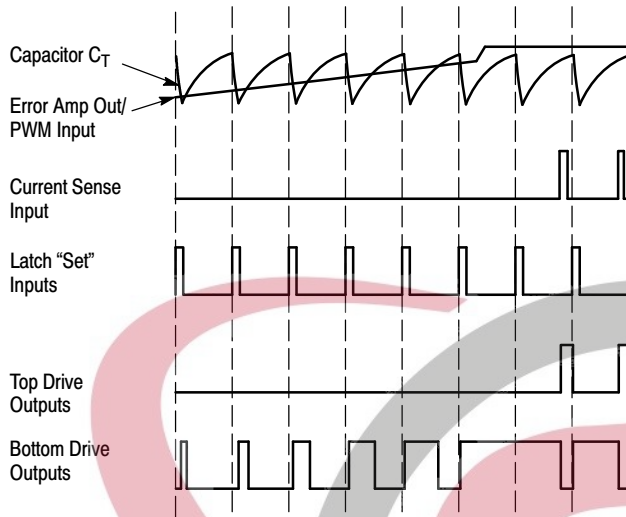
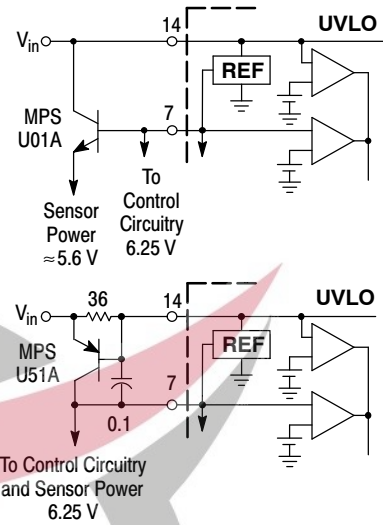
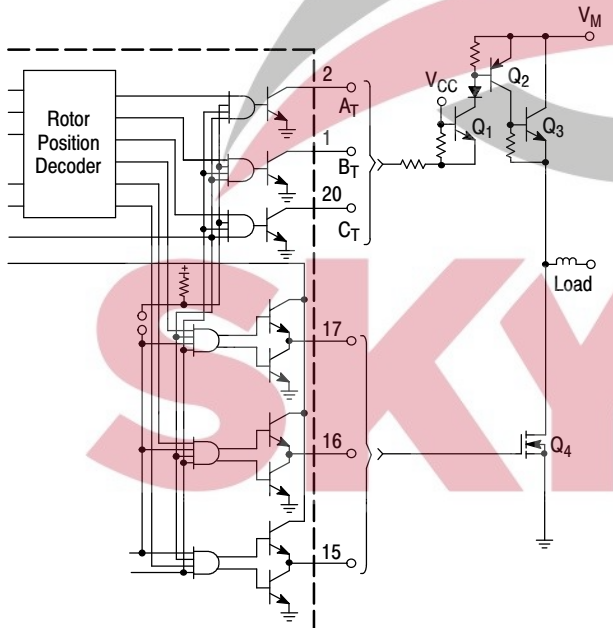

Figure 21. PWM Timing Diagram



The NPN circuit is recommended for powering Hall or opto sensors, where the output voltage temperature coefficient is not critical. The PNP circuit is slightly more complex, but also more accurate. Neither circuit has current limiting.

Figure 22. Reference Output Buffers



Transistor Q₁ is a common base stage used to level shift from V_{CC} to the high motor voltage, V_M. The collector diode is required if V_{CC} is present while V_M is low.

Figure 23. High Voltage Interface with NPN Power Transistors

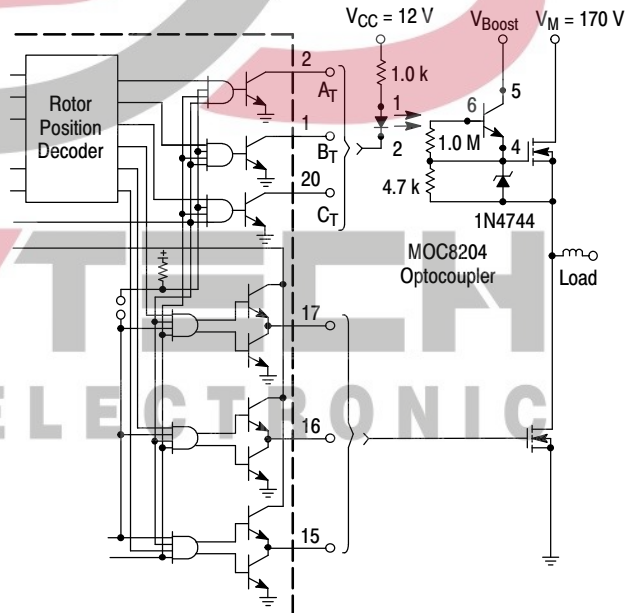
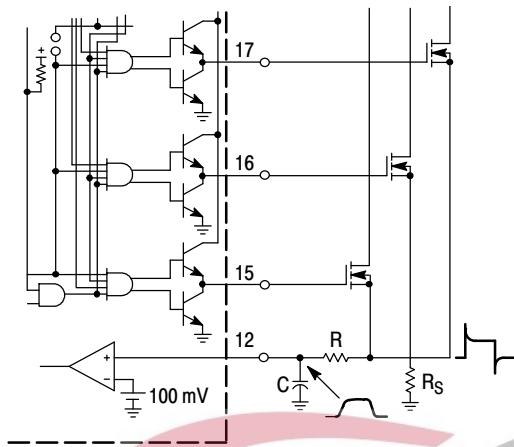
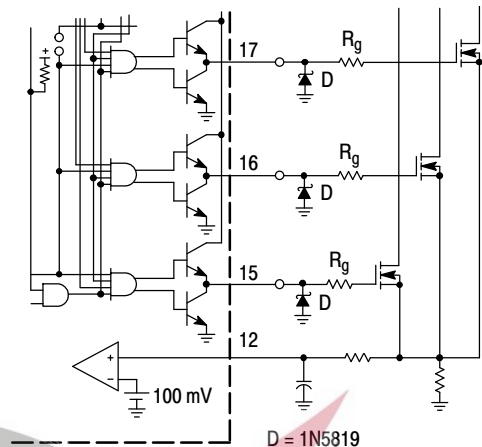

Figure 24. High Voltage Interface with N-Channel Power MOSFETs



The addition of the RC filter will eliminate current-limit instability caused by the leading edge spike on the current waveform. Resistor R_S should be a low inductance type.

Figure 25. Current Waveform Spike Suppression



Series gate resistor R_g will damp any high frequency oscillations caused by the MOSFET input capacitance and any series wiring inductance in the gate-source circuit. Diode D is required if the negative current into the Bottom Drive Outputs exceeds 50 mA.

Figure 26. MOSFET Drive Precautions

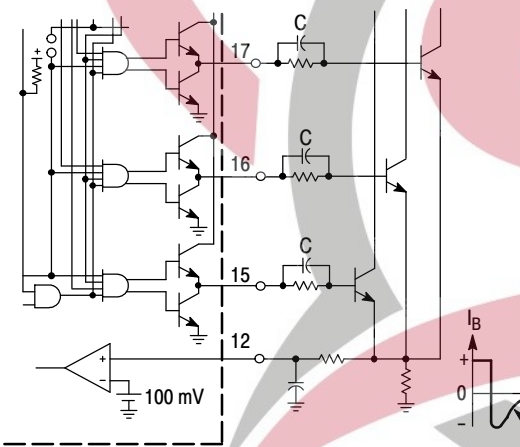

The totem pole output can furnish negative base current for enhanced transistor turn-off, with the addition of capacitor C.

Figure 27. Bipolar Transistor Drive

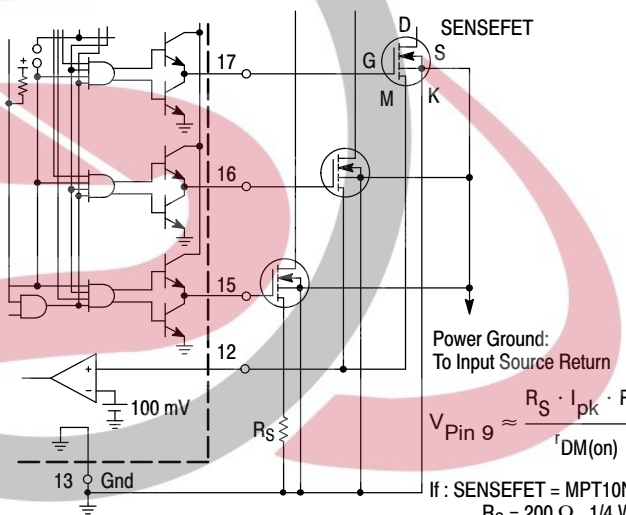

Power Ground:
To Input Source Return

$$V_{Pin\ 9} \approx \frac{R_S \cdot I_{pk} \cdot R_{DS(on)}}{r_{DM(on)} + R_S}$$

If: SENSEFET = MPT10N10M
 $R_S = 200\ \Omega$, 1/4 W
 Then: $V_{Pin\ 9} \approx 0.75 I_{pk}$

Virtually lossless current sensing can be achieved with the implementation of SENSEFET power switches.

Figure 28. Current Sensing Power MOSFETs

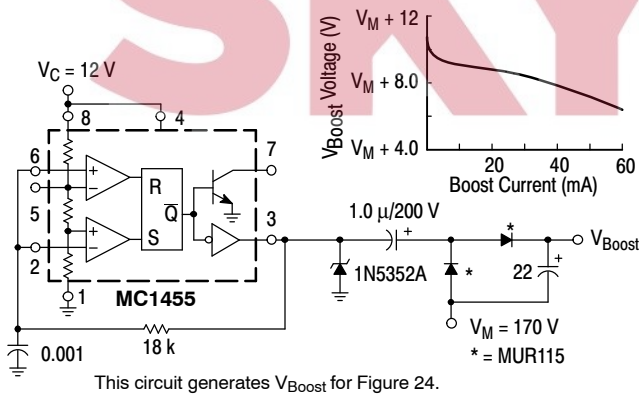
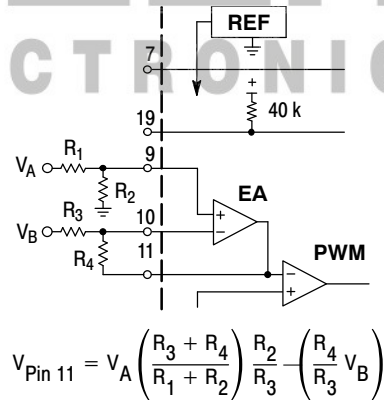
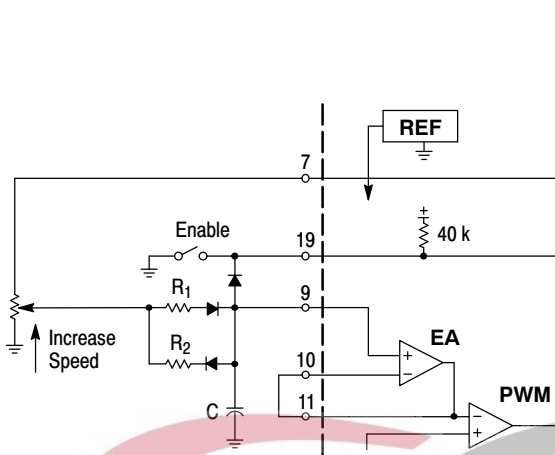

Figure 29. High Voltage Boost Supply



$$V_{Pin\ 11} = V_A \left(\frac{R_3 + R_4}{R_1 + R_2} \right) \frac{R_2}{R_3} - \left(\frac{R_4}{R_3} V_B \right)$$

Figure 30. Differential Input Speed Controller



Resistor R₁ with capacitor C sets the acceleration time constant while R₂ controls the deceleration. The values of R₁ and R₂ should be at least ten times greater than the speed set potentiometer to minimize time constant variations with different speed settings.

Figure 31. Controlled Acceleration/Deceleration

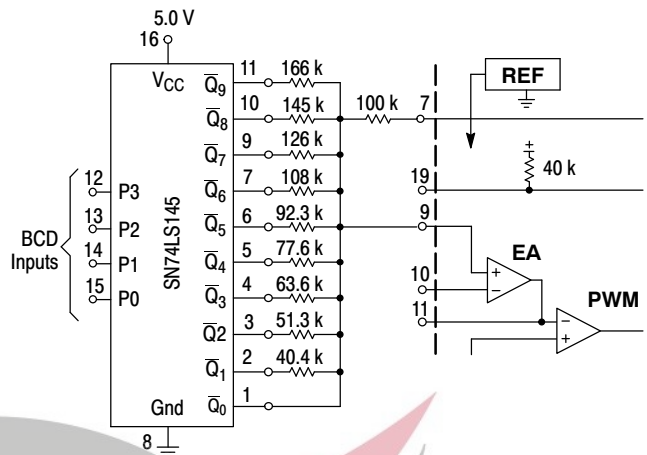

The SN74LS145 is an open collector BCD to One of Ten decoder. When connected as shown, input codes 0000 through 1001 steps the PWM in increments of approximately 10% from 0 to 90% on-time. Input codes 1010 through 1111 will produce 100% on-time or full motor speed.

Figure 32. Digital Speed Controller

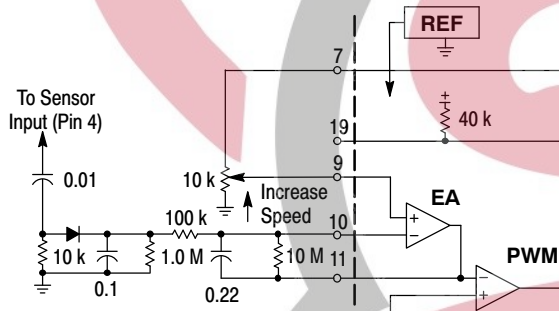

The rotor position sensors can be used as a tachometer. By differentiating the positive-going edges and then integrating them over time, a voltage proportional to speed can be generated. The error amp compares this voltage to that of the speed set to control the PWM.

Figure 33. Closed Loop Speed Control

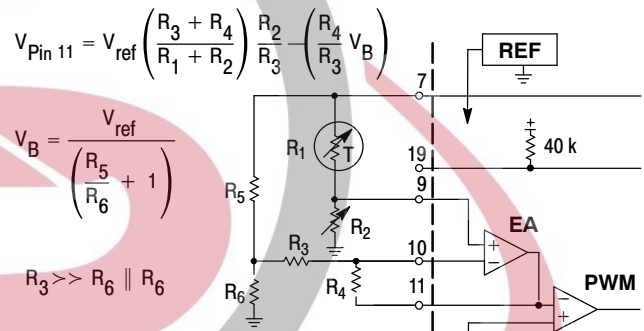

This circuit can control the speed of a cooling fan proportional to the difference between the sensor and set temperatures. The control loop is closed as the forced air cools the NTC thermistor. For controlled heating applications, exchange the positions of R₁ and R₂.

Figure 34. Closed Loop Temperature Control

Drive Outputs

The three Top Drive Outputs (Pins 1, 2, 20) are open collector NPN transistors capable of sinking 50 mA with a minimum breakdown of 30 V. Interfacing into higher voltage applications is easily accomplished with the circuits shown in Figures 23 and 24.

The three totem pole Bottom Drive Outputs (Pins 15, 16, 17) are particularly suited for direct drive of N-Channel MOSFETs or NPN bipolar transistors (Figures 25, 26, 27, and 28). Each output is capable of sourcing and sinking up to 100 mA.

Thermal Shutdown

Internal thermal shutdown circuitry is provided to protect the IC in the event the maximum junction temperature is exceeded. When activated, typically at 170°C, the IC acts as though the regulator was disabled, in turn shutting down the IC.

SYSTEM APPLICATIONS

Three Phase Motor Commutation

The three phase application shown in Figure 35 is an open loop motor controller with full wave, six step drive. The upper power switch transistors are Darlington PNPs while the lower switches are N-Channel power MOSFETs. Each of these devices contains an internal parasitic catch diode that is used to return the stator inductive energy back to the power supply. The outputs are capable of driving a delta or wye connected stator, and a grounded neutral wye if split supplies are used. At any given rotor position, only one top and one bottom power switch (of different totem poles) is enabled. This configuration switches both ends of the stator winding from supply to ground which causes the current flow to be bidirectional or full wave. A leading edge spike is usually present on the current waveform and can cause a current-limit error. The spike can be eliminated by adding

MC33033, NCV33033

an RC filter in series with the Current Sense Input. Using a low inductance type resistor for R_S will also aid in spike reduction. Figure 36 shows the commutation waveforms over two electrical cycles. The first cycle (0° to 360°) depicts motor operation at full speed while the second cycle (360°

to 720°) shows a reduced speed with about 50% pulse width modulation. The current waveforms reflect a constant torque load and are shown synchronous to the commutation frequency for clarity.

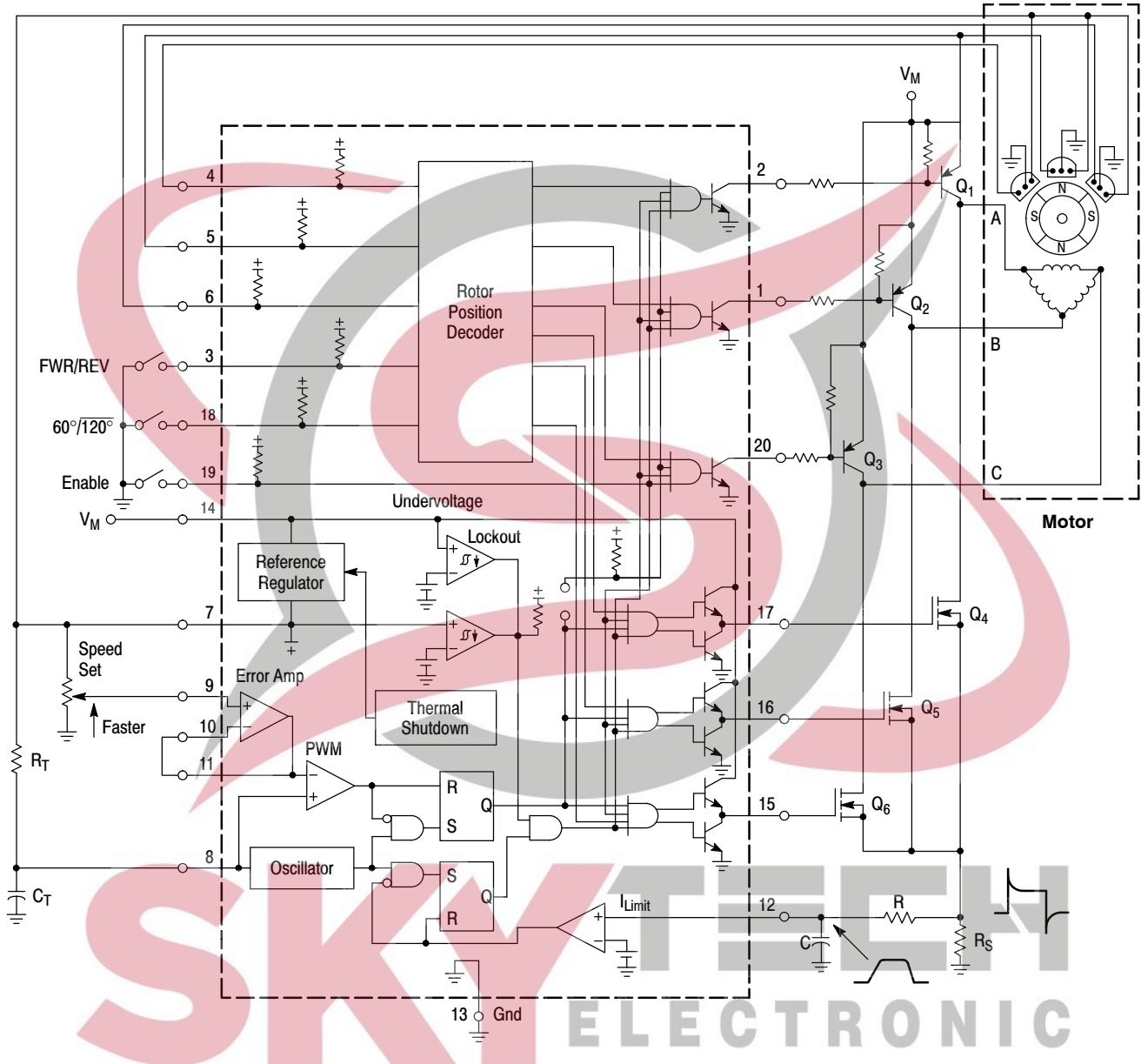

Figure 35. Three Phase, Six Step, Full Wave Motor Controller

MC33033, NCV33033

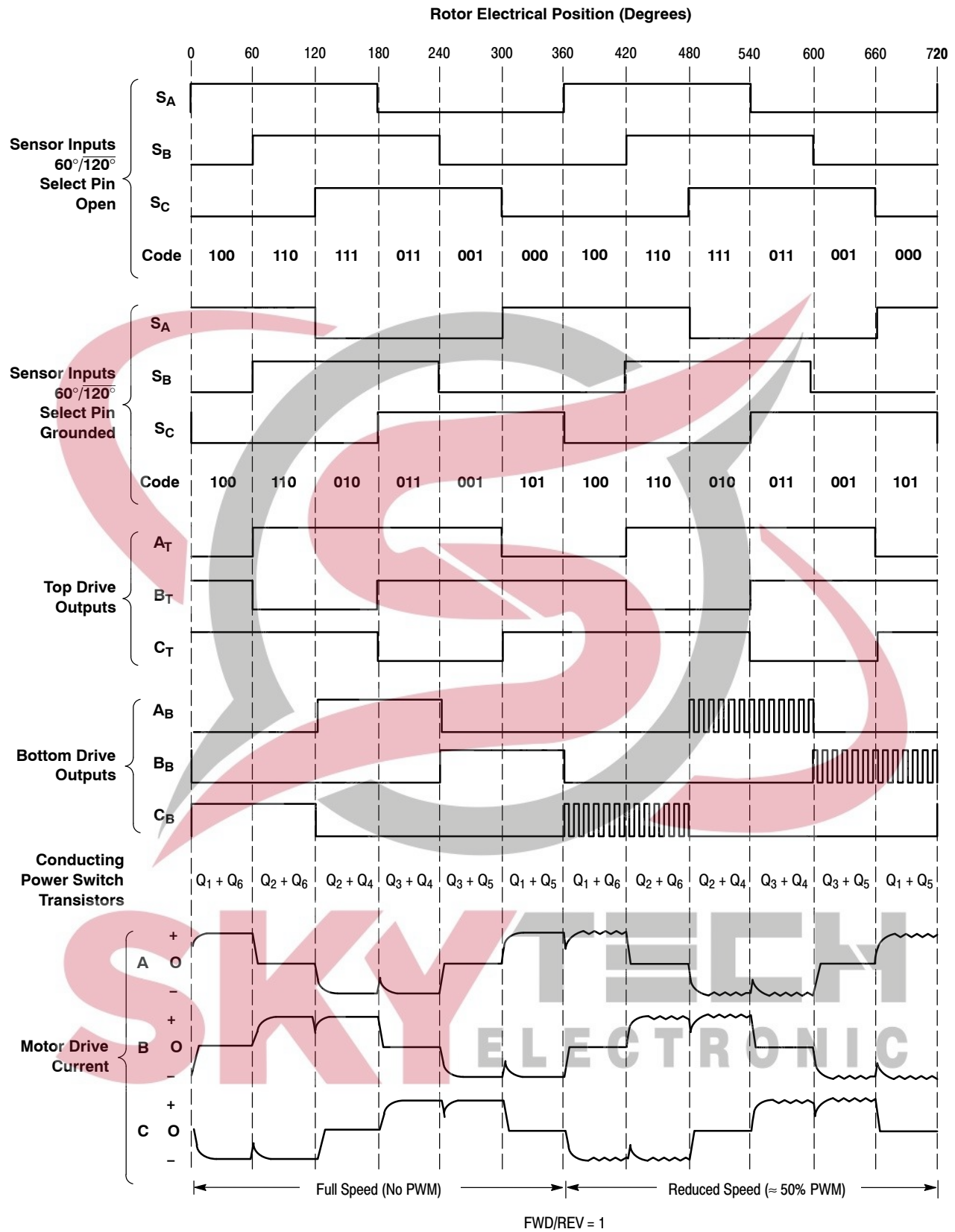

Figure 36. Three Phase, Six Step, Full Wave Commutation Waveforms

MC33033, NCV33033

Figure 37 shows a three phase, three step, half wave motor controller. This configuration is ideally suited for automobile and other low voltage applications since there is only one power switch voltage drop in series with a given

stator winding. Current flow is unidirectional or half wave because only one end of each winding is switched. The stator flyback voltage is clamped by a single zener and three diodes.

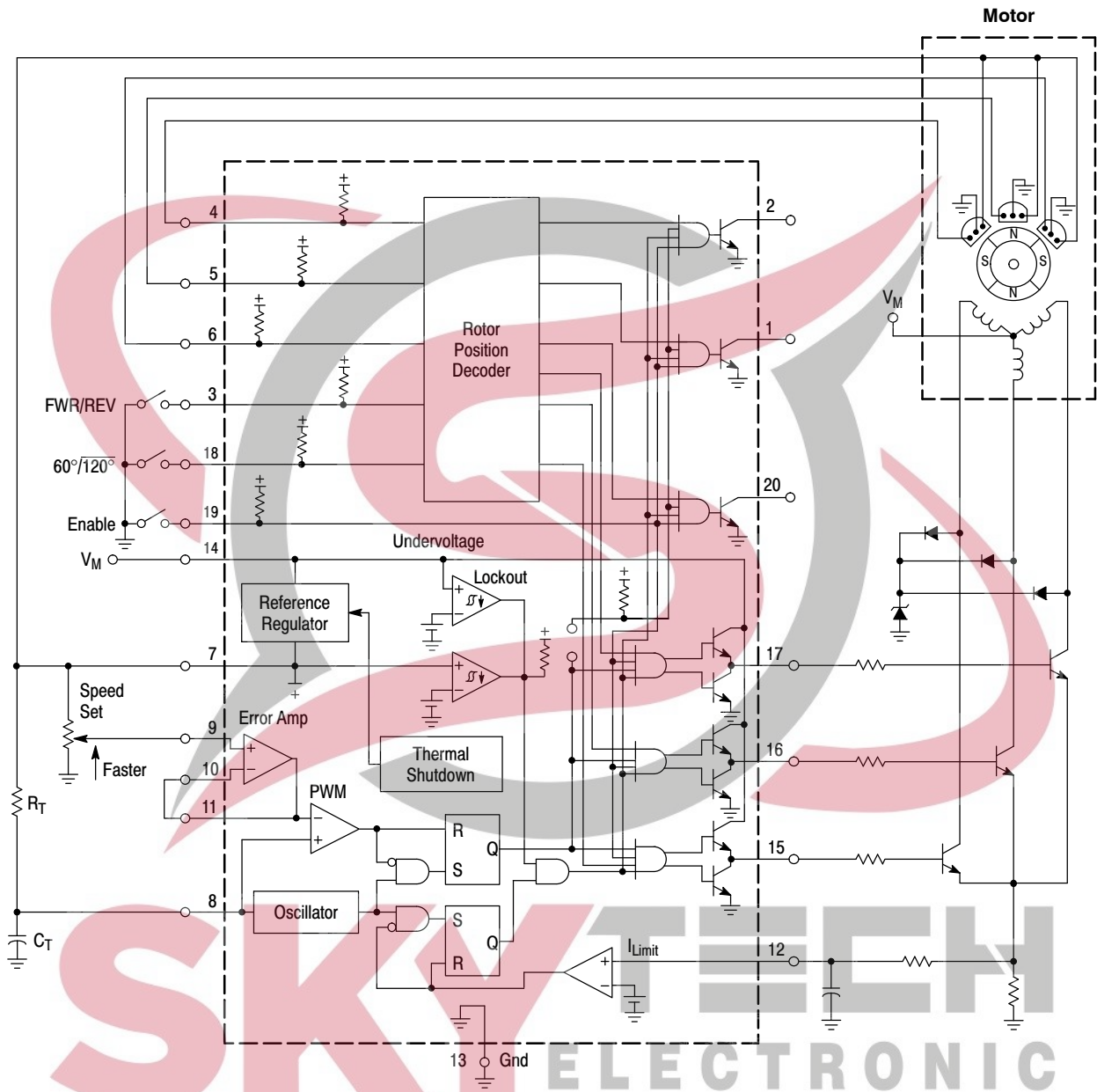

Figure 37. Three Phase, Three Step, Half Wave Motor Controller

Sensor Phasing Comparison

There are four conventions used to establish the relative phasing of the sensor signals in three phase motors. With six step drive, an input signal change must occur every 60 electrical degrees, however, the relative signal phasing is dependent upon the mechanical sensor placement. A comparison of the conventions in electrical degrees is shown in Figure 39. From the sensor phasing table (Figure 40), note that the order of input codes for 60° phasing is the reverse of 300°. This means the MC33033, when the 60°/120° select (Pin 18) and the FWD/REV (Pin 3) both in the high state (open), is configured to operate a 60° sensor phasing motor in the forward direction. Under the same conditions a 300° sensor phasing motor would operate equally well but in the reverse direction. One would simply have to reverse the FWD/REV switch (FWD/REV closed) in order to cause the 300° motor to also operate in the same direction. The same difference exists between the 120° and 240° conventions.

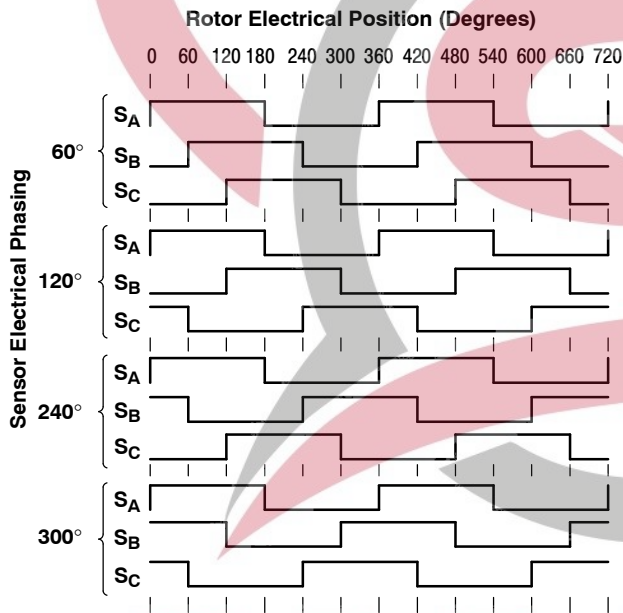

Figure 39. Sensor Phasing Comparison

Sensor Electrical Phasing (Degrees)											
60°			120°			240°			300°		
SA	SB	SC	SA	SB	SC	SA	SB	SC	SA	SB	SC
1	0	0	1	0	1	1	1	0	1	1	1
1	1	0	1	0	0	1	0	0	1	1	0
1	1	1	1	1	0	1	0	1	1	0	0
0	1	1	0	1	0	0	0	1	0	0	0
0	0	1	0	1	1	0	1	1	0	0	1
0	0	0	0	0	1	0	1	0	0	1	1

Figure 40. Sensor Phasing Table

In this data sheet, the rotor position has always been given in electrical degrees since the mechanical position is a function of the number of rotating magnetic poles. The relationship between the electrical and mechanical position is:

$$\text{Electrical Degrees} = \text{Mechanical Degrees} \left(\frac{\# \text{Rotor Poles}}{2} \right)$$

An increase in the number of magnetic poles causes more electrical revolutions for a given mechanical revolution. General purpose three phase motors typically contain a four pole rotor which yields two electrical revolutions for one mechanical.

Two and Four Phase Motor Commutation

The MC33033 configured for 60° sensor inputs is capable of providing a four step output that can be used to drive two or four phase motors. The truth table in Figure 41 shows that by connecting sensor inputs SB and SC together, it is possible to truncate the number of drive output states from six to four. The output power switches are connected to BT, CT, BB, and CB. Figure 42 shows a four phase, four step, full wave motor control application. Power switch transistors Q1 through Q8 are Darlington type, each with an internal parasitic catch diode. With four step drive, only two rotor position sensors spaced at 90 electrical degrees are required. The commutation waveforms are shown in Figure 43.

Figure 44 shows a four phase, four step, half wave motor controller. It has the same features as the circuit in Figure 37, except for the deletion of speed adjust.

MC33033 (60°/120° Select Pin Open)						
Inputs			Outputs			
Sensor Electrical Spacing* = 90°			Top Drives		Bottom Drives	
SA	SB	F/R	BT	CT	BB	CB
1	0	1	1	1	0	1
1	1	1	0	1	0	0
0	1	1	1	0	0	0
0	0	1	1	1	1	0
1	0	0	1	0	0	0
1	1	0	1	1	1	0
0	1	0	1	1	0	1
0	0	0	0	1	0	0

*With MC33033 sensor input SB connected to SC

Figure 41. Two and Four Phase, Four Step, Commutation Truth Table

MC33033, NCV33033

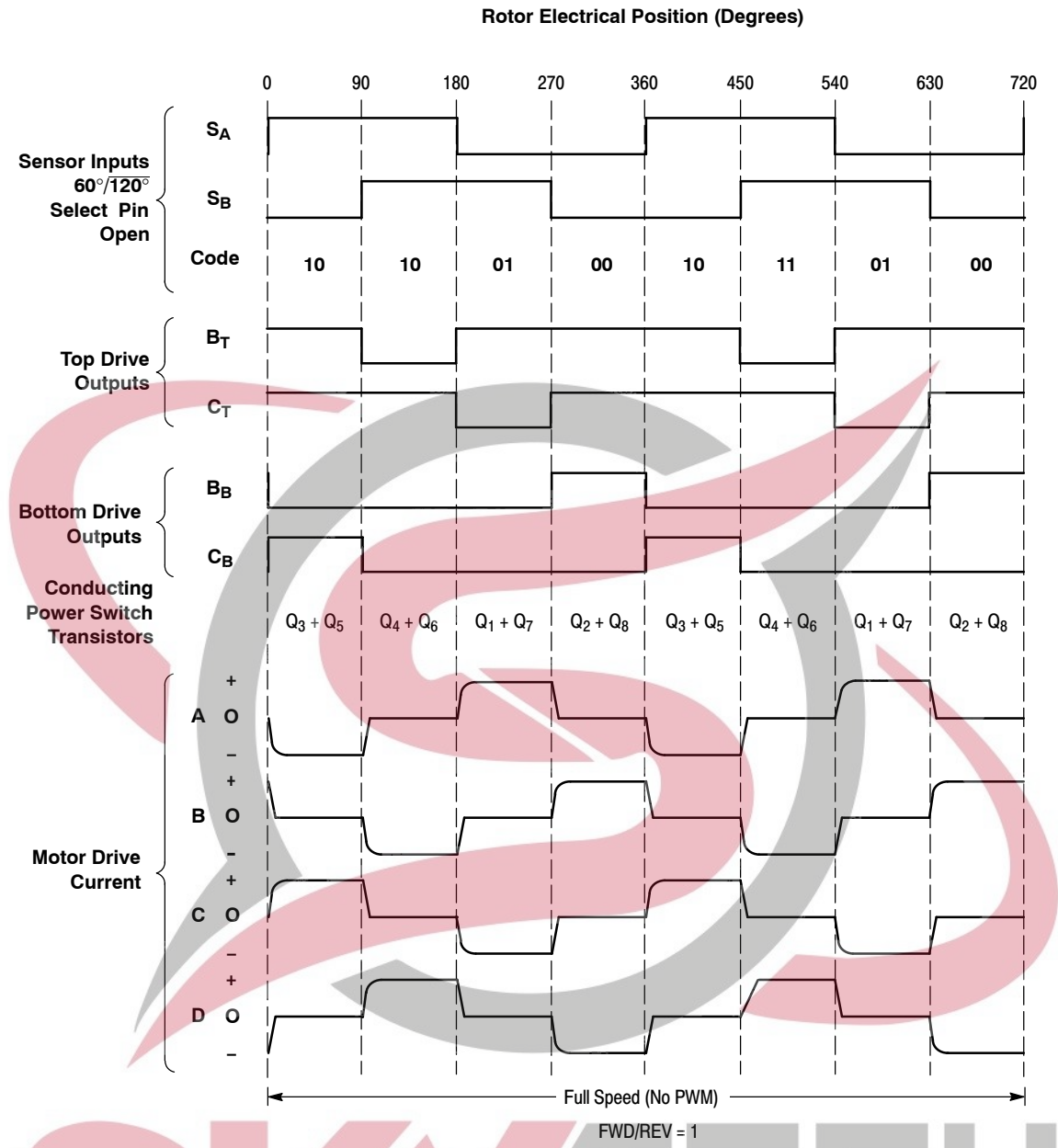

Figure 43. Four Phase, Four Step, Full Wave Commutation Waveforms



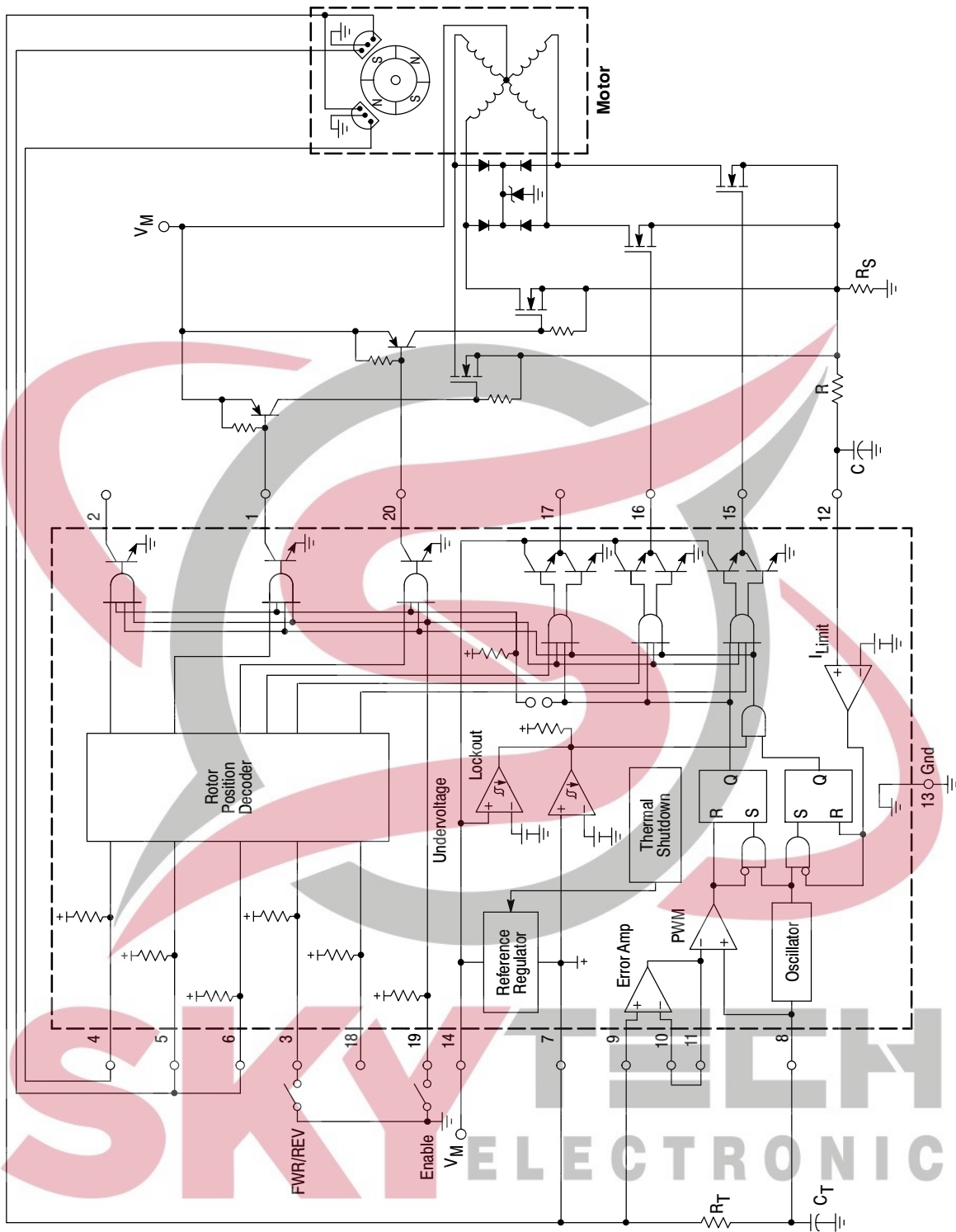

Figure 44. Four Phase, Four Step, Half Wave Motor Controller

Brush Motor Control

Though the MC33033 was designed to control brushless dc motors, it may also be used to control dc brush-type motors. Figure 45 shows an application of the MC33033 driving a H-bridge affording minimal parts count to operate a brush-type motor. Key to the operation is the input sensor code [100] which produces a top-left (Q_1) and a bottom-right (Q_3) drive when the controller's Forward/Reverse pin is at logic [1]; top-right (Q_4), bottom-left (Q_2) drive is realized when the Forward/Reverse pin is at logic [0]. This code supports the requirements necessary for H-bridge drive accomplishing both direction and speed control.

The controller functions in a normal manner with a pulse width modulated frequency of approximately 25 kHz. Motor speed is controlled by adjusting the voltage presented to the noninverting input of the Error Amplifier establishing the PWM's slice or reference level. Cycle-by-cycle current limiting of the motor current is accomplished by sensing the voltage (100 mV threshold) across the R_S resistor to ground of the H-bridge motor current. The over current sense circuit makes it possible to reverse the direction of the motor, on the

fly, using the normal Forward/Reverse switch, and not have to completely stop before reversing.

LAYOUT CONSIDERATIONS

Do not attempt to construct any of the motor control circuits on wire-wrap or plug-in prototype boards. High frequency printed circuit layout techniques are imperative to prevent pulse jitter. This is usually caused by excessive noise pick-up imposed on the current sense or error amp inputs. The printed circuit layout should contain a ground plane with low current signal and high drive and output buffer grounds returning on separate paths back to the power supply input filter capacitor V_M . Ceramic bypass capacitors (0.01 μ F) connected close to the integrated circuit at V_{CC} , V_{ref} and error amplifier noninverting input may be required depending upon circuit layout. This provides a low impedance path for filtering any high frequency noise. All high current loops should be kept as short as possible using heavy copper runs to minimize radiated EMI.

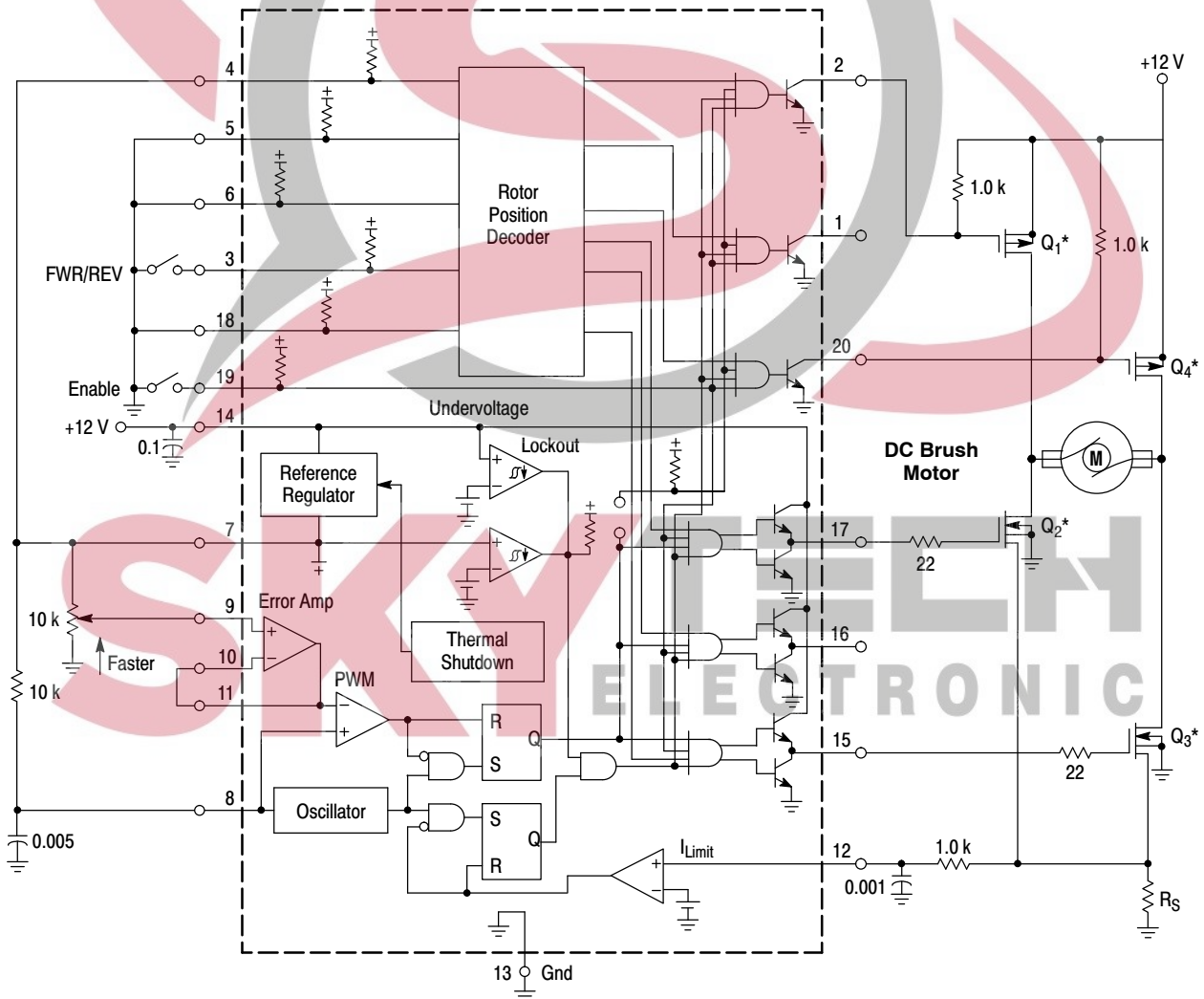

Figure 45. H-Bridge Brush-Type Controller

MC33033, NCV33033

ORDERING INFORMATION

Device	Operating Temperature Range	Package	Shipping [†]
MC33033DW	T _A = -40°C to +85°C	SO-20L	38 Units / Rail
MC33033DWG		SO-20L (Pb-Free)	
MC33033DWR2		SO-20L	1000 Tape & Reel
MC33033DWR2G		SO-20L (Pb-Free)	
MC33033P		PDIP-20	18 Units / Rail
MC33033PG		PDIP-20 (Pb-Free)	
NCV33033DWR2*	T _A = -40°C to +125°C	SO-20L	1000 Tape & Reel
NCV33033DWR2G*		SO-20L (Pb-Free)	

†For information on tape and reel specifications, including part orientation and tape sizes, please refer to our Tape and Reel Packaging Specification Brochure, BRD8011/D.

*NCV33033: T_{low} = -40C, T_{high} = +125C. Guaranteed by design. NCV prefix is for automotive and other applications requiring unique site and change control; AEC-Q100 Qualified and PPAP Capable.

MARKING DIAGRAMS

SO-20L
DW SUFFIX
CASE 751D

PDIP-20
P SUFFIX
CASE 738

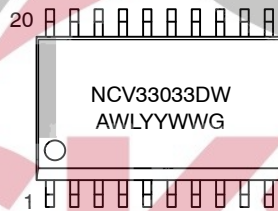
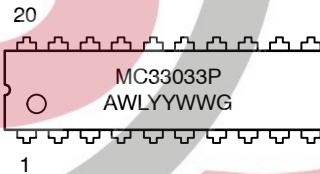
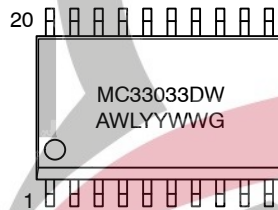

A = Assembly Location
 WL = Wafer Lot
 YY = Year
 WW = Work Week
 G = Pb-Free Package

MECHANICAL CASE OUTLINE
PACKAGE DIMENSIONS

ON Semiconductor®



PDIP
CASE 738-03
ISSUE E

DATE 06/26/1987



SCALE 1:1

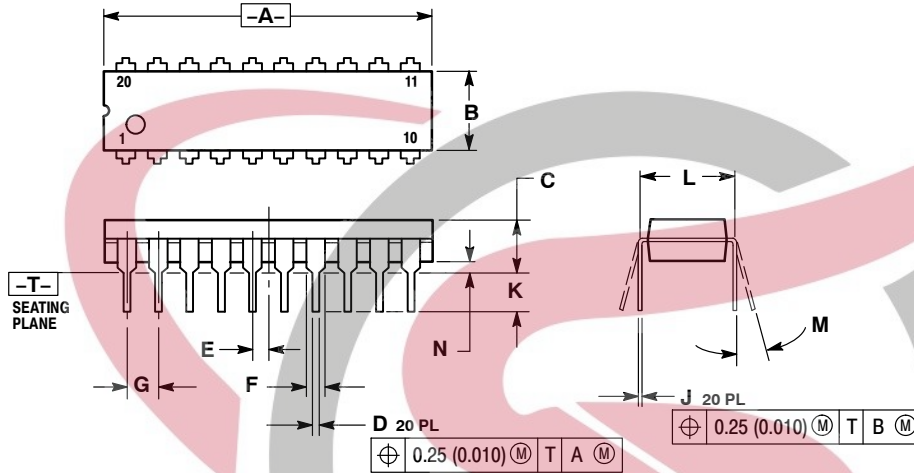

NOTES:

1. DIMENSIONING AND TOLERANCING PER ANSI Y14.5M, 1982.
2. CONTROLLING DIMENSION: INCH.
3. DIMENSION L TO CENTER OF LEAD WHEN FORMED PARALLEL.
4. DIMENSION B DOES NOT INCLUDE MOLD FLASH.

DIM	INCHES		MILLIMETERS	
	MIN	MAX	MIN	MAX
A	1.010	1.070	25.66	27.17
B	0.240	0.260	6.10	6.60
C	0.150	0.180	3.81	4.57
D	0.015	0.022	0.39	0.55
E	0.050 BSC		1.27 BSC	
F	0.050	0.070	1.27	1.77
G	0.100 BSC		2.54 BSC	
J	0.008	0.015	0.21	0.38
K	0.110	0.140	2.80	3.55
L	0.300 BSC		7.62 BSC	
M	0°	15°	0°	15°
N	0.020	0.040	0.51	1.01



DOCUMENT NUMBER:	98ASB42469B	Electronic versions are uncontrolled except when accessed directly from the Document Repository. Printed versions are uncontrolled except when stamped "CONTROLLED COPY" in red.
DESCRIPTION:	PDIP	PAGE 1 OF 1

ON Semiconductor and ON are trademarks of Semiconductor Components Industries, LLC dba ON Semiconductor or its subsidiaries in the United States and/or other countries. ON Semiconductor reserves the right to make changes without further notice to any products herein. ON Semiconductor makes no warranty, representation or guarantee regarding the suitability of its products for any particular purpose, nor does ON Semiconductor assume any liability arising out of the application or use of any product or circuit, and specifically disclaims any and all liability, including without limitation special, consequential or incidental damages. ON Semiconductor does not convey any license under its patent rights nor the rights of others.

www.onsemi.com

MECHANICAL CASE OUTLINE PACKAGE DIMENSIONS

ON Semiconductor®

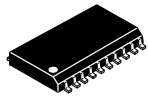

SCALE 1:1

SOIC-20 WB
CASE 751D-05
ISSUE H

DATE 22 APR 2015

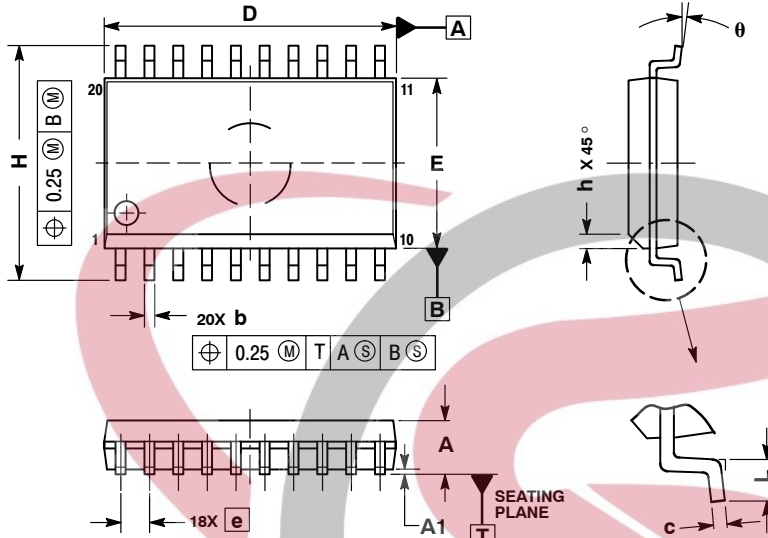

NOTES:

1. DIMENSIONS ARE IN MILLIMETERS.
2. INTERPRET DIMENSIONS AND TOLERANCES PER ASME Y14.5M, 1994.
3. DIMENSIONS D AND E DO NOT INCLUDE MOLD PROTRUSION.
4. MAXIMUM MOLD PROTRUSION 0.15 PER SIDE.
5. DIMENSION B DOES NOT INCLUDE DAMBAR PROTRUSION. ALLOWABLE PROTRUSION SHALL BE 0.13 TOTAL IN EXCESS OF B DIMENSION AT MAXIMUM MATERIAL CONDITION.

DIM	MILLIMETERS	
	MIN	MAX
A	2.35	2.65
A1	0.10	0.25
b	0.35	0.49
c	0.23	0.32
D	12.65	12.95
E	7.40	7.60
e	1.27 BSC	
H	10.05	10.55
h	0.25	0.75
L	0.50	0.90
θ	0°	7°

RECOMMENDED
SOLDERING FOOTPRINT*

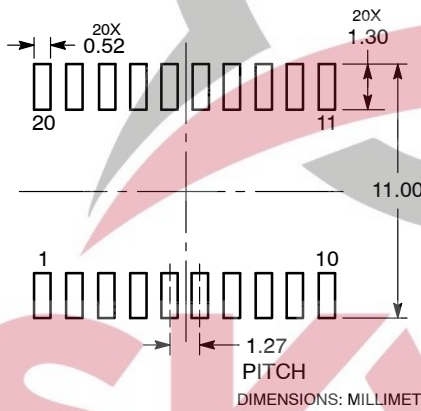

GENERIC
MARKING DIAGRAM*

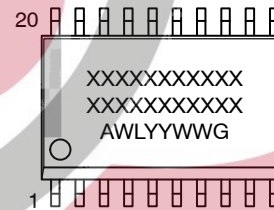

- XXXXX = Specific Device Code
- A = Assembly Location
- WL = Wafer Lot
- YY = Year
- WW = Work Week
- G = Pb-Free Package

*This information is generic. Please refer to device data sheet for actual part marking. Pb-Free indicator, "G" or microdot "▪", may or may not be present.

*For additional information on our Pb-Free strategy and soldering details, please download the ON Semiconductor Soldering and Mounting Techniques Reference Manual, SOLDERRM/D.

DOCUMENT NUMBER:	98ASB42343B	Electronic versions are uncontrolled except when accessed directly from the Document Repository. Printed versions are uncontrolled except when stamped "CONTROLLED COPY" in red.
DESCRIPTION:	SOIC-20 WB	PAGE 1 OF 1

ON Semiconductor and ON are trademarks of Semiconductor Components Industries, LLC dba ON Semiconductor or its subsidiaries in the United States and/or other countries. ON Semiconductor reserves the right to make changes without further notice to any products herein. ON Semiconductor makes no warranty, representation or guarantee regarding the suitability of its products for any particular purpose, nor does ON Semiconductor assume any liability arising out of the application or use of any product or circuit, and specifically disclaims any and all liability, including without limitation special, consequential or incidental damages. ON Semiconductor does not convey any license under its patent rights nor the rights of others.

www.onsemi.com



SKY **TECH**
ELECTRONIC

ON Semiconductor and  are trademarks of Semiconductor Components Industries, LLC dba ON Semiconductor or its subsidiaries in the United States and/or other countries. ON Semiconductor owns the rights to a number of patents, trademarks, copyrights, trade secrets, and other intellectual property. A listing of ON Semiconductor's product/patent coverage may be accessed at www.onsemi.com/site/pdf/Patent-Marking.pdf. ON Semiconductor reserves the right to make changes without further notice to any products herein. ON Semiconductor makes no warranty, representation or guarantee regarding the suitability of its products for any particular purpose, nor does ON Semiconductor assume any liability arising out of the application or use of any product or circuit, and specifically disclaims any and all liability, including without limitation special, consequential or incidental damages. Buyer is responsible for its products and applications using ON Semiconductor products, including compliance with all laws, regulations and safety requirements or standards, regardless of any support or applications information provided by ON Semiconductor. "Typical" parameters which may be provided in ON Semiconductor data sheets and/or specifications can and do vary in different applications and actual performance may vary over time. All operating parameters, including "Typicals" must be validated for each customer application by customer's technical experts. ON Semiconductor does not convey any license under its patent rights nor the rights of others. ON Semiconductor products are not designed, intended, or authorized for use as a critical component in life support systems or any FDA Class 3 medical devices or medical devices with a same or similar classification in a foreign jurisdiction or any devices intended for implantation in the human body. Should Buyer purchase or use ON Semiconductor products for any such unintended or unauthorized application, Buyer shall indemnify and hold ON Semiconductor and its officers, employees, subsidiaries, affiliates, and distributors harmless against all claims, costs, damages, and expenses, and reasonable attorney fees arising out of, directly or indirectly, any claim of personal injury or death associated with such unintended or unauthorized use, even if such claim alleges that ON Semiconductor was negligent regarding the design or manufacture of the part. ON Semiconductor is an Equal Opportunity/Affirmative Action Employer. This literature is subject to all applicable copyright laws and is not for resale in any manner.

PUBLICATION ORDERING INFORMATION

LITERATURE FULFILLMENT:

Email Requests to: orderlit@onsemi.com

ON Semiconductor Website: www.onsemi.com

TECHNICAL SUPPORT

North American Technical Support:

Voice Mail: 1 800-282-9855 Toll Free USA/Canada

Phone: 011 421 33 790 2910

Europe, Middle East and Africa Technical Support:

Phone: 00421 33 790 2910

For additional information, please contact your local Sales Representative



Mouser Electronics

Authorized Distributor

Click to View Pricing, Inventory, Delivery & Lifecycle Information:

[ON Semiconductor:](#)

[MC33033DW](#) [MC33033DWG](#) [MC33033DWR2](#) [MC33033DWR2G](#) [MC33033P](#) [MC33033PG](#)

